



RW302 RIALTA SERIES

LED COLUMN

DIMENSIONS
6" Ø
6' to 16' TALL

7 YEAR WARRANTY

LUMEN RANGE
1890 to 2050

LIFE SPAN
L70
MINIMUM
100,000
HOURS

UL LISTED

CLICK FOR FAQ'S

JOB NAME _____

FIXTURE TYPE _____

MEMO _____

BUILD A PART NUMBER

ORDERING EXAMPLE: **PT10-RW302-6L40TS-MDLO5/BKT**

Mounting Configuration	Overall Height (In Feet)*	Fixture	LED	CCT	Distribution Type	Driver	Option Control Receptacle	Option Control	Option Fuse	Finish

*Specify height for "PT" mounting configuration ONLY.

Mounting Configuration

(Click here to link to mounting configuration specification page)

- IW
- SF4
- 2A
- 3A90
- PT
- SF5
- 2A90
- 4A
- SH¹
- 1A
- 3A

IW = Wall Mount PT = Post Top SH = Stem Hung SF4 = Slip Fit INSIDE 4" shaft SF5 = Slip Fit INSIDE 5" shaft A = Arm Mount

¹ Include overall drop length in inches after designation for Stem/Chain application (IE: SH - 48")

Overall Height (In Feet)²

• ___' (Available from 6' to 16')

² Post top heights over 12' require the Wide Base mount (see back page)

Fixture

- RW302

LED

- 6L

CCT - Color Temperature (K)

- 27(00)
- 30(00)
- 40(00)
- 50(00)

Distribution Type

- TS (Symmetric)

Driver

- MDLO5 (120V-277V, 480mA)
- MDH05 (347V-480V, 480mA)

Options (Click here to view paint options sheet)

- R³ 3-Pin control receptacle only
- R5³ 5-Pin control receptacle only
- R7³ 7-Pin control receptacle only
- PE⁴ Twist-Lock Photocontrol (120V-277V)
- PE3⁴ Twist-Lock Photocontrol (347V)
- PE4⁴ Twist-Lock Photocontrol (480V)
- SC⁴ Shorting Cap
- PEC Electronic Button Photocontrol (120V-277V)

- PEC⁴ Electronic Button Photocontrol (480V)
- FHD⁵ Double Fuse and Holder

³ Not for use with "SH" mounting configuration.

⁴ Requires control receptacle.

⁵ Ships loose for installation in base.

Finish

Standard Urban Finishes

(Click here to view paint finish sheet)

- UGMT Gun Metal Textured
- UGM Gun Metal Matte
- UBT Urban Bronze Textured
- UB Urban Bronze Matte
- ULBT Urban Light Bronze Textured
- ULB Urban Light Bronze Matte
- USLT Urban Silver Textured
- USL Urban Silver Matte
- UWHT Urban White Textured
- UWH Urban White Matte
- UCHS Urban Champagne Satin Smooth
- BKT Black Textured

Custom Urban Finish⁶

- CM Custom Match

⁶ Custom colors require upcharge.

Specifications

General

The RW302 luminaire is a cylindrical luminaire offered in a variety of mounting options. Designed to bring ambiance to any project by providing a performance lighting package in a vertical form. The 6" cylinder adds a 15" high luminous element. The RW302 uses a Six LED board configuration to deliver a symmetrical distribution with high efficiency and low wattage consumption. The Luminaire shall be UL listed in US and Canada.

LED's

The luminaire shall use high output, high brightness LED's. They shall be mounted in arrays, on printed circuit boards designed to maximize heat transfer to the heat sink surface. The LED's and printed circuit boards shall be 100% recyclable; they shall also be protected from moisture and corrosion by a conformal coating of 1 to 3 mils. They shall not contain lead, mercury or any other hazardous substances and shall be RoHS compliant. The LED life rating data shall be determined in accordance with IESNA LM-80. The High Performance white LED's will have a life expectancy of approximately 100,000 hours with not less than 70% of original brightness (lumen maintenance), rated at 25°C. The High Brightness, High Output LED's shall be 4000K (5000K, 3000K or 2700K option) color temperature with a minimum CRI of 70. Consult factory for custom color CCT. The luminaire shall have a minimum _____ (see table) delivered initial lumen rating when operated at steady state with an average ambient temperature of 25°C (77°F).

Optics

The luminaire shall be provided with individual, collimating type optics applied to each LED. The luminaire shall provide a symmetric distribution with near perfect surface brightness and uniformity.

Electronic Driver

The LED driver shall be U.L. Recognized. It shall be securely mounted inside the bollard, for optimized performance and longevity. It shall be supplied with a quick-disconnect electrical connector on the power supply, providing easy power connections and fixture

See next page



SternbergLighting

ESTABLISHED 1923 / EMPLOYEE OWNED

800-621-3376
555 Lawrence Ave., Roselle, IL 60172
info@sternberglighting.com
www.sternberglighting.com

RW302 RIALTA SERIES

LED COLUMN

installation. It shall have overload as well as short circuit protection, and have a DC voltage output, constant current design, 50/60HZ. It shall be supplied with line-ground, line-neutral and neutral-ground electrical surge protection in accordance with IEEE/ANSI C62.41.2 guidelines. It shall be dimmable using a 0-10v signal. The driver shall have a minimum efficiency of 88%.

Installation

For the "PT" mounting configuration, four 1/2" diameter, hot-dipped galvanized "L" type anchor bolts shall be provided with the post for anchorage. **FOR USE WITH HEIGHTS LESS THAN OR EQUAL TO 12'** they shall be mounted

in a 3-1/4" bolt circle. **FOR USE WITH HEIGHTS GREATER THAN 12'**, they shall be mounted in a 8-3/4" bolt circle. A door shall be provided for wiring and anchor bolt access. It shall be secured with tamper proof stainless steel hardware. Post will be provided with a grounding stud mounted behind the access door.

Photocontrols

Button Style: The photocontrol shall be mounted on an access door and pre-wired to driver. The electronic button type photocontrol is instant on with a 5-10 second turn off, and shall turn on at 1.5 footcandles with a turn-off at 2-3 footcandles. Photocontrol is 120-277 volt and warranted for 6 years.

Twist-Lock Style: The photocontrol shall be mounted externally on the fixture and pre-wired to driver. The twist lock type photocontrol is instant on with a 3-6 second turn off, and shall turn on at 1.5 footcandles with a turn-off at 2-3 footcandles. Photocontrol is 120-277 volt and warranted for 6 years.

Warranty

Seven-year limited warranty. See product and finish warranty guide for details.

Finish

Refer to website for details.

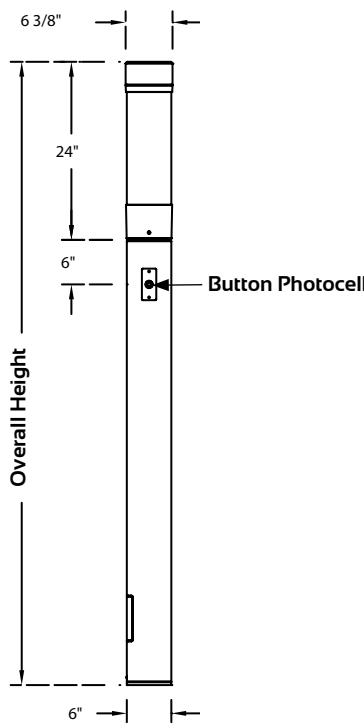
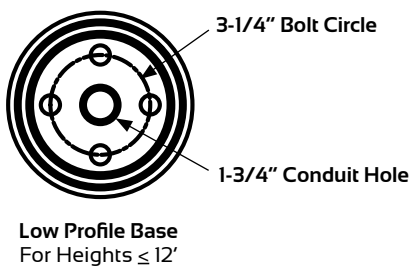
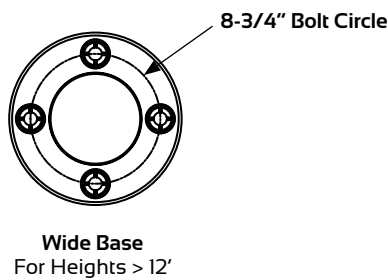

Low Profile Base
For Heights ≤ 12'

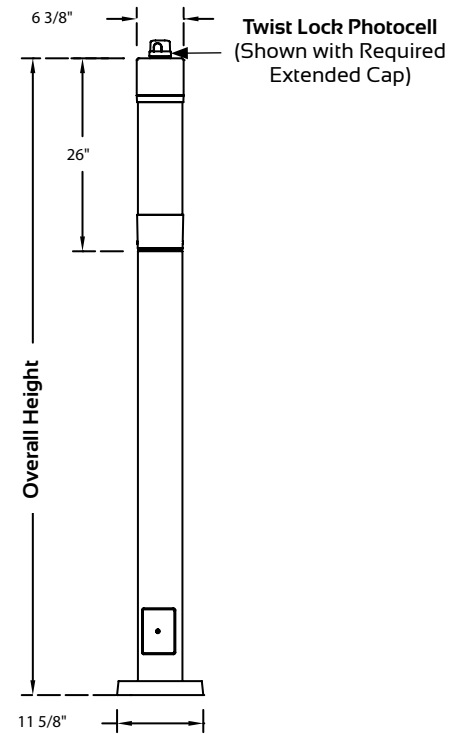

Wide Base
For Heights > 12'

RW302 RIALTA SERIES

LED COLUMN

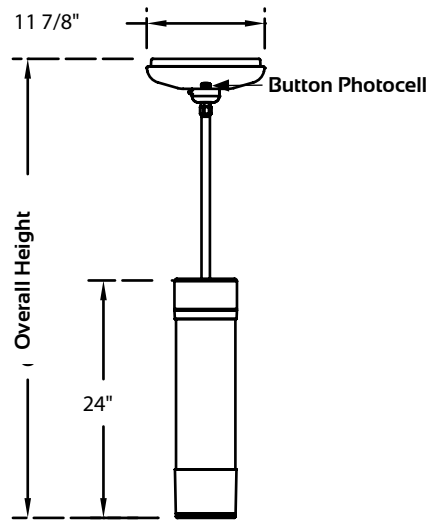

SH
Stem Hung Mount

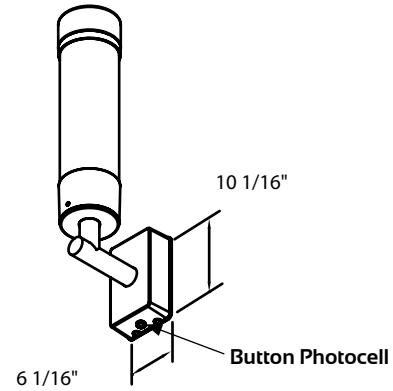

IW
Wall Mount

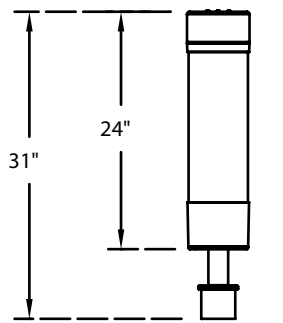

SF_
Slip Fit Mount

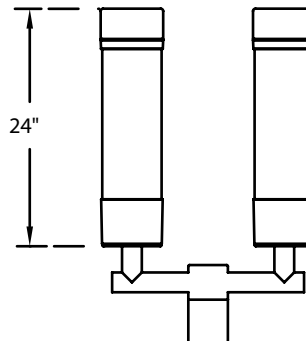

2A
2 Arm Mount

See [Mounting Configuration](#) page for more mounting options.
(Click here to link to mounting configuration specification page)

Performance

Model #	TS LUMENS	EFFICACY (LPW)	WATTAGE
RW302-6L40TS-MDL05	2050	46.6	44
RW302-6L30TS-MDL05	1955	44.4	44
RW302-6L27TS-MDL05	1890	43.0	44