

# FL630 FLIGHT SERIES

LED



EPA  
0.47 (ft<sup>2</sup>)  
WEIGHT  
21 LBS

7 YEAR  
WARRANTY

LUMEN  
RANGE  
4,895 to  
9,240

LIFE SPAN  
L70  
MINIMUM  
100,000  
HOURS



JOB NAME \_\_\_\_\_

FIXTURE TYPE \_\_\_\_\_

MEMO \_\_\_\_\_

## BUILD A PART NUMBER

ORDERING EXAMPLE: **2A-FL630-IL40T3-MDL12-SV2-R-PE-FHD-RP345/RSS12F400/UBKT**

Mounting Config.	Fixture	LED	CCT	Type	Driver	Lens	Optional Control Receptacle	Optional Control	Optional Motion Sensor	Optional Fuse	Optional House Side Shield	Optional Adapter	Arm See Arm Spec Sheets	Pole See Pole Spec Sheets	Finish

### Mounting Configuration

(Click here to link to mounting configuration specification page)

- 1W<sup>1</sup>
- 1A
- 2A
- 2A90
- 3A
- 3A90
- 4A
- 1AM
- 2AM

W = Wall Mount A = Arm Mount AM = Arm Mid-Mount

<sup>1</sup>Requires optional FMA or FOIM.

### Fixture

- FL630

### LED

- IL

### CCT - Color Temperature (K)

- 27(00)
- 30(00)
- 40(00)
- 50(00)

### Type

- T2<sup>2</sup>
- T3<sup>3</sup>
- T5<sup>3</sup>

<sup>2</sup>For use with SV1 lens only.

<sup>3</sup>For use with SV2 lens only.

### Driver

- MDL12 (120v-277v, 1200mA)
- MDL16 (120v-277v, 1600mA)
- MDH12 (347v-480v, 1200mA)
- MDH16 (347v-480v, 1600mA)

### Lens

- SV1 (Flat Soft Vue Light Diffuse Acrylic)
- SV2 (Flat Soft Vue Moderate Diffuse Acrylic)

### Options (Click here to view accessories sheet)

- R<sup>4</sup> 3-Pin control receptacle only
- R5<sup>4</sup> 5-Pin control receptacle only
- R7<sup>4</sup> 7-Pin control receptacle only
- PE<sup>5</sup> Twist-Lock Photocontrol (120v-277v)
- PE3<sup>5</sup> Twist-Lock Photocontrol (347v)
- PE4<sup>5</sup> Twist-Lock Photocontrol (480v)
- SC<sup>5</sup> Shorting Cap
- MOT1<sup>6</sup> 360° lens, maximum coverage 40' diameter from 20' height
- MOT2<sup>6</sup> 360° lens, maximum coverage 70' diameter from 20' height
- FHD<sup>7</sup> Double Fuse and Holder
- HSS 120° House Side Shield

- RP345 Round Pole Adapter for 3", 4" or 5" diameter pole shafts
- MA 2-3/8" Mast Arm Adapter
- FMA Flat Mount Adapter

<sup>4</sup>Requires RP345, FMA, 1W-FO15 or Post Cap

<sup>5</sup>Requires control receptacle

<sup>6</sup>Requires extension casting or sweep arm. (RP345, FMA or FOIM)

<sup>7</sup>Ships loose for installation in base.

### Arm

- FOIM Medium Swept Arm

### Pole (Click here to link to pole specification page)

See Pole specification sheets.

### Finish (Click here to view paint finish sheet)

#### Standard Urban Finishes

- UGMT Urban Gun Metal Textured
- UGM Urban Gun Metal Matte
- UBT Urban Bronze Textured
- UB Urban Bronze Matte
- ULBT Urban Light Bronze Textured
- ULB Urban Light Bronze Matte
- USLT Urban Silver Textured
- USL Urban Silver Matte
- UWHT Urban White Textured
- UWH Urban White Matte
- UCHS Urban Champagne Satin Smooth
- BKT Black Textured

#### Custom Urban Finishes<sup>8</sup>

- CM Custom Match

<sup>8</sup>Custom colors require upcharge.

## Specifications

### Fixture

The FL630 Flight luminaire is a 20" diameter Die Cast constructed luminaire with a single inverted mount COB optic. Photometric performance is achieved by a segmented reflector system that will deliver low glare illumination through its SoftVue™ lens system. The single electronic driver will power the COB delivering better than 80% efficacy.

The high efficiency Heat pipe thermal management system ensures a service life of greater than 100,000 hours based on L-70. The luminaire shall be UL listed in US and Canada.

### LED's

The luminaire shall use high output, high brightness LED's. The LED's and printed circuit boards shall be environmentally friendly and 100% recyclable, they shall also be protected from moisture and corrosion by a conformal coating of 1 to 3 mils. They shall not contain lead, mercury or any other hazardous substances and shall be RoHS compliant.

The LED life rating data shall be determined in accordance with IESNA LM-80. The High Performance white LED's will have a minimum life expectancy of approximately 100,000 hours with not less than 70% of original brightness (lumen maintenance), rated at 25°C. The High Brightness, High Output LED's shall be 4000K (2700K, 3000K or 5000K option) color temperature with a minimum of 70 CRI. Consult factory for custom color CCT. The luminaire shall have a minimum \_\_\_\_\_ (see table) delivered initial lumen rating when operated at steady state with an average ambient temperature of 25°C (77°F).

### Optics

The optical system shall consist of a multi-piece segmented optical image duplicating system using reflector pieces of polished Alzak™, Hammertone aluminum or a combination of the two. Each will surround the COB light emitter. When paired with Sternberg's SoftVue™ lens system unparalleled glare mitigation is achieved. Heat pipe technology effectively removes thermal stress on the electronic components by transmitting thermal energy through the liquid filled system and away from sensitive components. Excess heat is transmitted to the outside atmosphere via heat pipe and finned heat sync assembly integrally mounted to the luminaire optical system. IES distribution patterns of type (2, 3 and 5) will be achieved.

See next page

# FL630 FLIGHT SERIES

LED

## Electronic Driver

The LED driver shall be U.L. Recognized. It shall be securely mounted inside the fixture, for optimized performance and longevity. It shall be supplied with a quick-disconnect electrical connector on the power supply, providing easy power connections and fixture installation. It shall have overload, overheat and short circuit protection, and have a DC voltage output, constant current design, 50/60HZ. It shall be supplied with line-ground, line-neutral and neutral-ground electrical surge protection in accordance with IEEE/ANSI C62.41.2 guidelines. It shall be a high efficiency driver with a THD less than 20% and a high power factor greater than .9. It shall be dimming capable using a 0-10v signal, consult factory for more information.

## Photocontrols

**Twist-Lock Style:** The photocontrol shall be mounted externally on the fixture and pre-wired to driver. The twist lock type photocontrol is instant on with a 3-6 second turn off, and shall turn on at 1.5 footcandles with a turn-off at 2-3 footcandles. Photocontrol is 120-277 volt and warranted for 6 years.

## Warranty

Seven-year limited warranty. See product and finish warranty guide for details.

## Finish

Refer to website for details.

## Performance

LIGHT SOURCE	T2 DELIVERED LUMENS	EFFICACY (LPW)	T3 DELIVERED LUMENS	EFFICACY (LPW)	T5 DELIVERED LUMENS	EFFICACY (LPW)	WATTAGE
FL630-1L27T_-MDL16	6925	74.5	6440	69.3	7945	85.5	93
FL630-1L30T_-MDL16	7790	83.8	7260	78.1	8960	96.4	93
FL630-1L40T_-MDL16	8060	86.7	7485	80.5	9240	99.4	93
FL630-1L27T_-MDL12	5280	80.0	4895	74.2	6015	91.2	66
FL630-1L30T_-MDL12	5940	90.0	5525	83.7	6785	102.8	66
FL630-1L40T_-MDL12	6145	93.1	5695	86.3	6995	106.0	66

## Fixtures

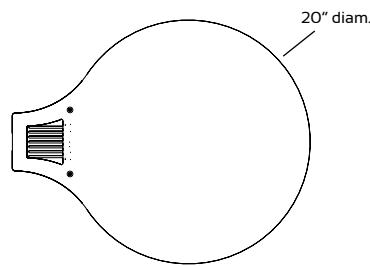

FL630

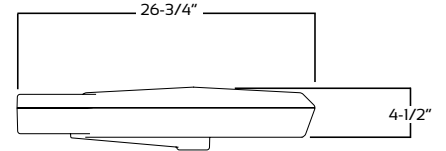

## Options

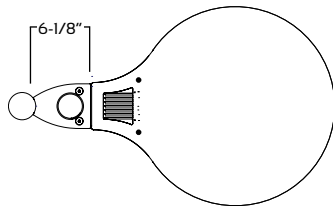

**RP345 & R-PE & MOTI**  
Round Pole Adapter,  
Twist-lock Photocontrol  
& Motion Sensor

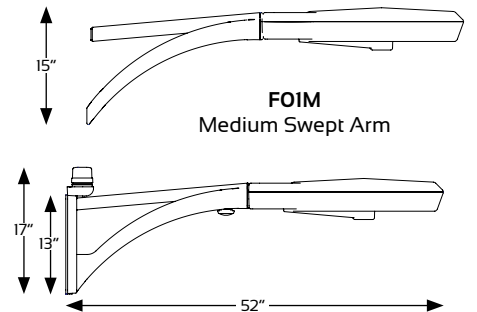
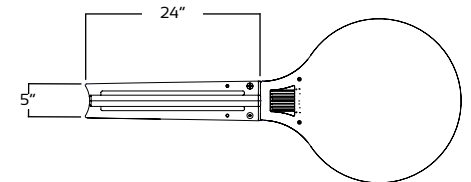
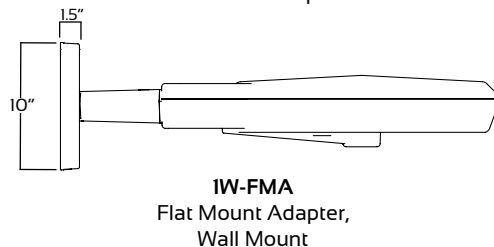
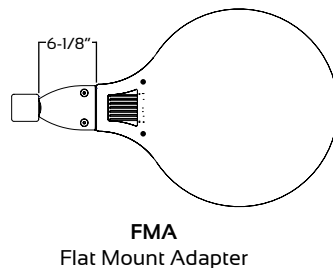
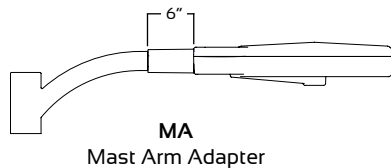

**IW-FOIM-R-PE-MOTI**  
Wall Mount, Medium Sweep Arm  
Twist-Lock Photocontrol & Motion Sensor

20"