

**2001SS MESA ROADWAY 7.5" Diameter**

**SPECIFICATIONS**

**GENERAL**

The \_\_\_ ft tall decorative post shall be aluminum or steel, one piece construction. The post shall have a cast aluminum, decorative two-piece split base that clamps around the pole and base plate. The 18" diameter x 48" tall cover shall have one access door.

**CONSTRUCTION**

The base shall be designed with a decorative curviform shape and transition to a curved hour-glass shaft. It shall be made of heavy wall, 356 alloy cast aluminum. **Indicate the type of shaft needed.**

\_\_\_ The **round tapered fluted shaft** shall be made of ASTM A572 grade 50, high-strength structural steel or ASTM 6063T6 aluminum.

\_\_\_ The **round tapered smooth shaft** shall be made of ASTM 6063T6 extruded aluminum and tempered to a T6 condition or ASTM A572 steel.

\_\_\_ The **round straight fluted shaft** shall be made of ASTM A595 grade A, high-strength structural steel or ASTM 6061T6 aluminum.

\_\_\_ The **round straight smooth shaft** shall be made of ASTM 6061T6 extruded aluminum and tempered to a T6 condition or ASTM A572 steel. It shall have a decorative fluted tenon.

\_\_\_ The **octagonal tapered shaft** shall be made of ASTM A607 high-strength, tapered structural steel.

**INSTALLATION**

The cast aluminum fluted base cover shall clamp around the base plate and lower shaft of the pole assembly. It shall be clamped together using tamper-proof stainless steel screws. An access door shall be provided in the pole shaft and in the cast aluminum fluted base cover for wiring and mechanically secured with tamper-proof, stainless steel screws.

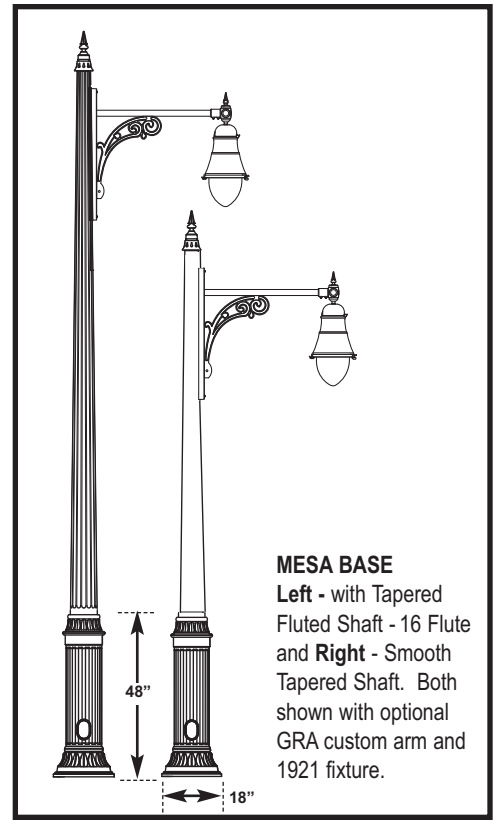

**MESA BASE**  
Left - with Tapered Fluted Shaft - 16 Flute and Right - Smooth Tapered Shaft. Both shown with optional GRA custom arm and 1921 fixture.

**Roadway Arms Available for 2001SS Mesa Series**

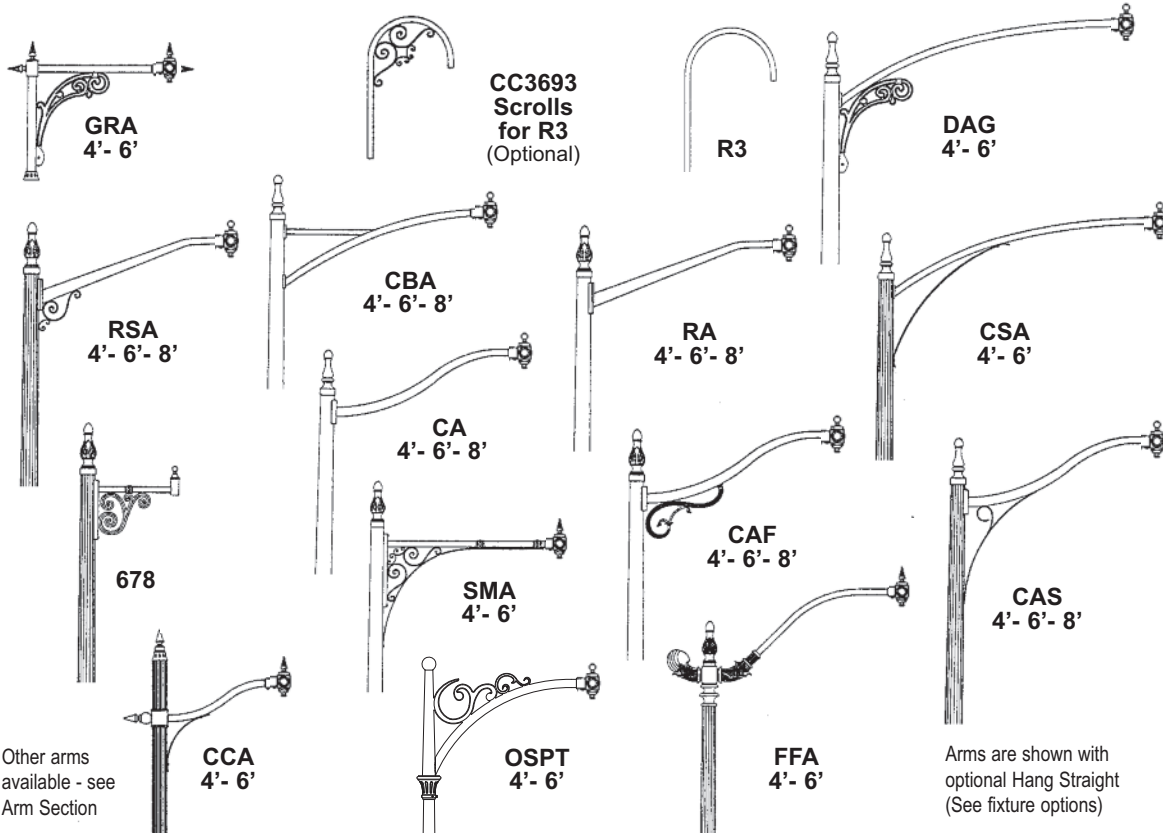

**POLE HEIGHT CALCULATOR**

Add distance listed below to desired mounting height of fixture to calculate pole height needed.

**ARM**

- CAS -2'
- CA -1'
- CAF -1'
- CSA -2'
- RA -1'
- RSA -1'
- DAG -2'
- SMA +1'
- GRA -3'
- CCA +1'
- CBA 0
- DA -7'
- R3 -3'
- FFA -3'
- OSPT -3'
- 678 0

Arms are shown with optional Hang Straight (See fixture options)







Other arms available - see Arm Section

# 2001SS MESA ROADWAY 7.5" Diameter POSTS / OPTIONS / POST CAPS

## BUILDING A PART NUMBER

MODEL	*POLE HEIGHT	SHAFT MATERIAL	SHAFT STYLE	FLUTED SHAPE (If Applicable)	POST CAP CENTER	OPTIONS	FINISH
20	25	S	RTF		RDBP		BK

### Part Number Selections

MODEL	*POLE HEIGHT	SHAFT MATERIAL	SHAFT SHAPE	FLUTED SHAPE (If Applicable)	SHAFT TYPE (Pole Shapes)
• 20	<ul style="list-style-type: none"> <li>• 20'</li> <li>• 23'</li> <li>• 25'</li> <li>• 30'</li> <li>• 32'</li> </ul>	<ul style="list-style-type: none"> <li>• S-Steel</li> <li>• A-Aluminum</li> <li>• G-Galvanized</li> </ul>	<ul style="list-style-type: none"> <li>• RTF - Round Tapered Fluted</li> <li>• RTS - Round Tapered Smooth</li> <li>• RSF - Round Straight Fluted</li> <li>• RSS - Round Straight Smooth</li> <li>• OTS** - Octagonal Tapered Smooth <small>**Steel Only</small></li> </ul>	<ul style="list-style-type: none"> <li>• 16FF</li> <li>• 16SF</li> <li>• 12FF</li> <li>• 12SF</li> <li>• 8SF</li> </ul>	<div style="display: flex; justify-content: space-around;"> <div style="text-align: center;"> <p>16-Sharp Flute</p>  </div> <div style="text-align: center;"> <p>16-Flat Flute</p>  </div> <div style="text-align: center;"> <p>12-Flat Flute</p>  </div> </div> <div style="display: flex; justify-content: space-around; margin-top: 10px;"> <div style="text-align: center;">  <p>Round</p> </div> <div style="text-align: center;">  <p>8-Sharp Flute</p> </div> <div style="text-align: center;">  <p>Octagonal</p> </div> </div>

Shaft diameters and wall thickness will be determined by the factory, based on desired pole design with selected options and basic wind velocity (Referenced by AASHTO). Check your local area for wind speed or any other structural requirements.





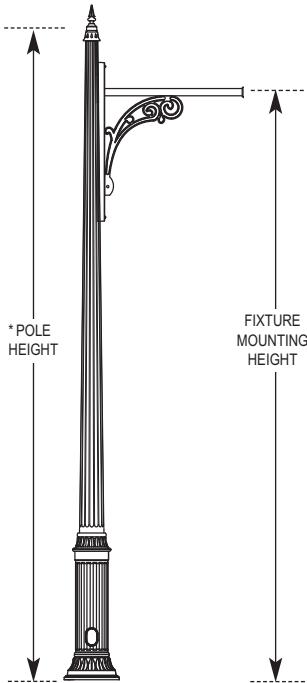









\*Use Pole Height Calculator to determine pole height based on desired mounting height of fixture.

All Tapered Shafts have a taper of 0.14 inch per foot of length, most shafts are available in steel and/or aluminum.



## OPTIONS AVAILABLE

See Accessories Section for more options and information

 <b>GFI</b> - Ground Fault Interrupter mounts in the pole   <b>FH</b> - Flag Pole Holder mounts on the pole   <b>HS-B</b> Hang Straight Ball   <b>HS-F</b> Hang Straight Finial	 <b>SBA</b> - Single Banner Arm mounts on the pole   <b>DBA</b> - Double Banner Arms mount on same side of the pole   <b>SBAR</b> - Single Banner Arm and Ring   <b>DSPA</b> - Double Stepped Planter Arms mount on either side   <b>DHPA</b> - Double Hooked Planter Arms mount on either side   <b>PA478</b> - Decorative Planter Arms with planter rings	 <b>PCD</b> - Photo Control mounts on door on pole   <b>SH</b> - Speaker Hub for mounting speaker, floodlight or signal   <b>SB</b> - Sign Bracket mounts on pole to hold signs   <b>WHK</b> - Wreath Hook mounts on pole to hold decorations
---	---	---

## POST CENTER CAPS (If Required)

### POST CENTER CAP

- RC
- RBCC3
- RSSCC
- RSB4
- RSB5
- RPBP
- RDBP

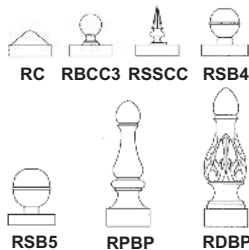

### OPTIONS AVAILABLE (Above)

- GFI
- FH
- SBA
- DBA
- DB Direct Burial
- SBAR
- DSPA
- DHPA
- PA478
- HB Helix Burial
- PCD
- SH
- SB
- WHK

### STANDARD FINISHES\*

- BKT Black Textured
- WHT White Textured
- PGT Park Green Textured
- ABZT Architectural Medium Bronze Textured
- DBT Dark Bronze Textured

\*Smooth Finishes are available upon request

### CUSTOM FINISHES

- OI Old Iron

- RT Rust
- WBR Weathered Brown
- CD Cedar
- WBK Weathered Black
- TT Two Tone

### STERNBERG SELECT FINISHES

- VG Verde Green
- SI Swedish Iron
- OWGT Old World Gray Textured