

# 1710 VILLA SERIES

# SPECIFICATIONS

## GENERAL

The 1710 Villa fixture is a small scale, dramatic design. It features a tall, cylindrical architectural body consisting of a decorative cast cage, round lens and round flat roof shade. It shall provide tool-less access for ease of maintenance.

## POST FITTER

The fitter shall be heavy wall cast aluminum, 356 alloy for high tensile strength. It shall have an inside diameter opening to accept a 3" or 4" round pole or tenon. When ordered with a Sternberg aluminum pole, the fitter shall be set screwed to the pole top or tenon.

## BALLAST HOUSING

The ballast housing shall be heavy wall cast aluminum, 356 alloy for high tensile strength. The housing shall be cast as an integral part of the fitter to prevent water entry into the ballast compartment and to ensure high capacity heat sinking of ballast temperatures, keeping the ballast cooler and ensuring long life. The ballast mounting plate shall be cast aluminum and provide tool-less removal from the housing using 2 ea finger latches.

## ELECTRICAL

Fixture shall be U.L. or E.T.L. listed in U.S. and Canada. H.I.D. ballasts shall be high power factor with lamp starting down to -30 degrees C. Medium base and mogul base porcelain sockets are 4KV rated. The ballast/socket assembly shall be pre-wired when ballast is located in the fixture. All compact fluorescent (PL) ballasts shall be instant start electronic with a starting temperature of down to 0 degrees F. They shall have a 4-pin socket to accept quad or triple tube lamps. Ballasts shall be DOE EISA compliant.

## FIXTURE HOUSING

The 1710 fixture shall be 20" wide and the overall height shall be 21". It shall be made of heavy wall cast aluminum, 356 alloy, aluminum shade and lens will be made of vandal resistant clear or frosted polycarbonate.

## OPTICAL OPTIONS

Refractors shall be 5" diameter borosilicate glass with an I.E.S. Type 3 (RE3) or Type 5 (RE5) distribution. It shall be secured to the socket stem with 3/8" plated steel threaded pipe nipple and rest on a cast aluminum holder with anti-shock gasket. The refractor will be secured to cast holder with a quarter-turn internal aluminum twist ring for ease of maintenance.

The **Louver Reflector System (LR5)** shall be a multi-tier reflector with 5" diameter rings to produce an I.E.S. Type 5 distribution. The Louver Reflector System shall be made of specular anodized aluminum and shall come standard with medium base socket.

**Frosted Glass Mission Chimney (FMC)** is an optic option which adds an authentic touch.

**House Side Shield (HSS)** is an option which will block up to 120° of light in any one direction.

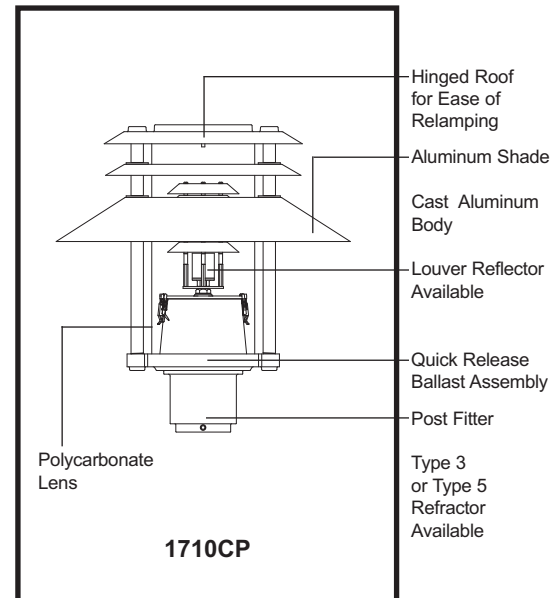







**EPA = 0.56 (ft²)**  
**WEIGHT = 24 LBS**

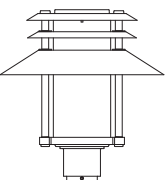
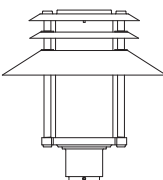

# 1710 VILLA

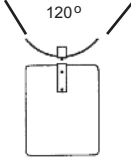

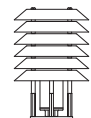
# FIXTURES/FITTERS/ARMS PM-WB

FIXTURES	POST FITTERS	OPTICAL SYSTEMS
----------	--------------	-----------------

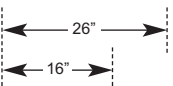
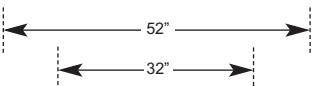
20" W	20" W					
		 <b>R3"</b>  <b>R4"</b> SIZES				
<b>1710CP</b> Clear Polycarbonate Lens	<b>1710FP</b> Frosted Polycarbonate Lens		<b>RE3</b> <b>RE5</b> Refractor	<b>HSS</b> House Side Shield	<b>FMC</b> Frosted Mission Chimney	<b>LR5</b> Louver Reflector

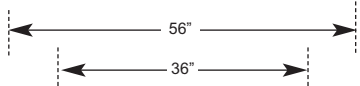
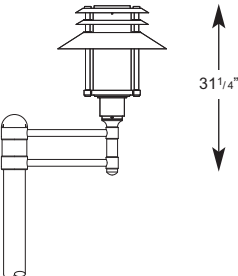
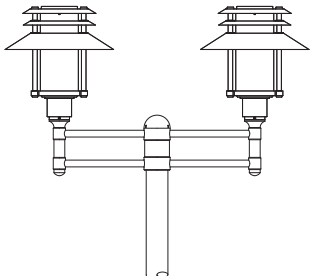
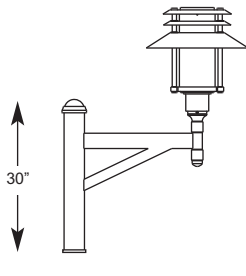
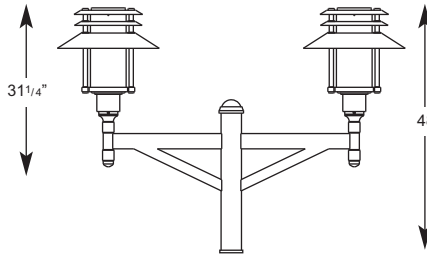
ARMS - POST MOUNT or WALL BRACKETS (WB)	See Arms Section for more information
---	---------------------------------------

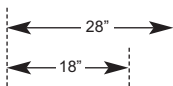
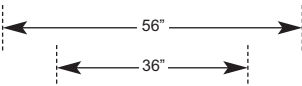
			
			
<b>OMS SINGLE</b>	<b>OMS TWIN</b>	<b>HMSPT SINGLE</b>	<b>HMSPT TWIN</b>

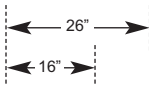
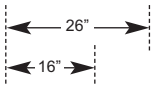
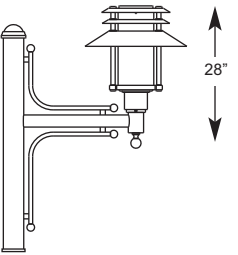
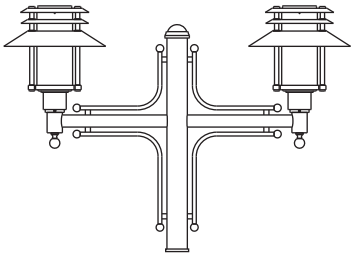
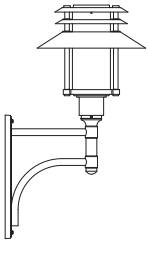
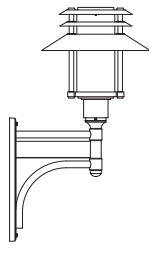
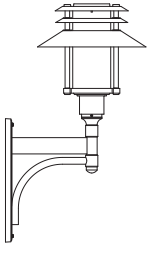
				
				
<b>OLS SINGLE</b>	<b>OLS TWIN</b>	<b>VCS</b>	<b>VLS</b>	<b>VFS</b>

# BUILDING A PART NUMBER



## POST & ARM FIXTURES

ARM MOUNTED FIXTURE	CENTER POST TOP FIXTURE (PT)	POST	POST CAP	LIGHT SOURCE BALLAST	OPTICS	OPTIONS	FINISH
NO. OF ARMS 2	FIXTURE / POSTARM 1710CP/HMSPT	FIXT./FITTER PT	(See Post Section) 3210P4	WATTS / TYPE / VOLTS 100 MHP120	LR5	PEC	BK

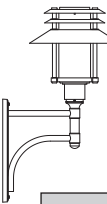

## WALL FIXTURES

FIXTURE / WALL BRACKET	LIGHT SOURCE BALLAST	OPTICS	OPTIONS	FINISH
1710CP/VCSWB	WATTS / TYPE / VOLTS 100 MHP120	LR5	MHP100/MED	BK

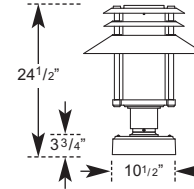

**PIER FIXTURES**  
Uses same information boxes as wall fixture  
**1710FP/450PB**  
FIXTURE / PIER BASE

## PART NUMBER SELECTIONS

### FIXTURE

- 1710CP
- 1710FP

### FITTERS

- R3
- R4

### OPTICS

- RE3
- RE5
- HSS
- FMC<sup>2</sup>
- LR5<sup>2</sup>

### POST ARMS

- OMSPT
- HMSPT
- OLSPT
- VCSPM
- VLSPM
- VFSPM

### VOLTAGES

- 120
- 208
- 240
- 277
- 480
- MULTI (120-277)

### WALL BRACKET ARMS

- OMSWB
- HMSWB
- OLSWB
- VCSWB
- VLSWB
- VFSWB

### PIER BASE

- 450PB

### BALLASTS<sup>3,4</sup>

- 35HPS<sup>1</sup>
- 50HPS
- 70HPS
- 100HPS
- 50MHP
- 70MHP
- 100MHP

### LAMPS<sup>4</sup>

- HPS35/MED
- HPS50/MED
- HPS70/MED
- HPS100/MED
- MHP50/MED
- MHP70/MED
- MHP100/MED

### STANDARD FINISHES\*

- BKT Black Textured
- WHT White Textured
- PGT Park Green Textured
- ABZT Architectural Medium Bronze Textured
- DBT Dark Bronze Textured

\*Smooth Finishes are available upon request

### CUSTOM FINISHES

- OI Old Iron
- RT Rust
- WBR Weathered Brown
- CD Cedar
- WBK Weathered Black
- TT Two Tone

### STERNBERG SELECT FINISHES

- VG Verde Green
- SI Swedish Iron
- OWGT Old World Gray Textured

### OPTIONS

- PEC1 Photocell-Bimetal 120 Volt
- PEC2 Photocell-Bimetal 208-277 Volt
- PEC1-E Photocell-Electronic 120 Volt
- PEC2-E Photocell-Electronic 208-277 Volt
- FHS Single Fuse and Holder-120,277 Volt
- FHD Dual Fuse and Holder-208,240,480 Volt
- QR Quartz Re-Strike
- LAMPS Select from List

### NOTES:

- <sup>1</sup> 35HPS is 120 volt only.
- <sup>2</sup> MED base only when used to house lamp.
- <sup>3</sup> Medium base sockets standard
- with ballasts up to 150 watts HID.
- 4-pin for PL.
- <sup>4</sup> Metal halide systems are pulse start.

# 1710 VILLA SERIES

# SPECIFICATIONS

**LIST NO. 1710  
VILLA  
SERIES**

## **QUARTZ RE-STRIKE**

The 1710 fixture can be supplied with an optional quartz re-strike system to retain constant fixture light if the H.I.D. lamp fails. The fixture will be equipped with a 100 watt quartz lamp and a controller to run on a 120 volt circuit and must be used in conjunction with a 120 volt or multi-tap ballast.

## **PHOTOCELLS**

Photocells shall be either the thermo bi-metal button type or the electronic button type. On single post top fixtures the photocell shall be mounted in the fitter and pre-wired to ballast. On multiple head fixture assemblies photocells shall be mounted in the pole shaft on an access plate and are not pre-wired as ballast housing assemblies and fitters are packaged separately for ease of wiring to source. The thermo bi-metal photocell shall be designed to turn on at 1.0 footcandle and turn off at not more than 5 footcandles. The electronic button type photocell is instant on and a 5-10 second turn off and shall turn on at 1.5 footcandles with a turn-off at 2-3 footcandles. Photocells are either 120 volt or 208 thru 277 volt.

## **ARMS**

All arms are made of cast aluminum and/or extruded aluminum. Arms with decorative filigree have meticulously detailed scroll work and gracefully curved brackets. All 1710 fixtures shall be bolted to the arm to ensure arms will be plumb, secure and level over the life of the installation.

## **FINISH**

Prior to coating, each assembly shall be chemically cleaned and etched in a 5-stage washing system which includes alkaline cleaning, rinsing, phosphoric etching, reverse osmosis water rinsing and non-chrome sealing to ensure corrosion resistance and excellent adhesion for the finish coating. The finish coating shall be electrostatically applied semi-gloss, super durable polyester powder baked at 400 degrees for a durable and superior, color retentive finish. Our optional antique Verde Green finish and Swedish Iron finish are hand brushed using a 3-step process. The total assembly shall be wrapped in shockproof wrapping or fully enclosed in corrugated cartons.

## **WARRANTY**

Five-year limited warranty. See product and finish warranty guide for details.

