



SOLANA® SL735

The Solana® SL735 Arm Mount Luminaire's stylish design is a perfect accent for urban settings. The subtle, yet sophisticated look enhances the impact of any project. The Solana's wide array of optics, lenses and distributions makes this an easy choice for a variety of commercial, institutional and municipal projects.



PROJECT: _____

TYPE: _____

ORDERING EXAMPLE: 1-U01¹-SL735-FG-140L45T3-F-MDL05-R1-MOT1-HSS-FHD/UWHT

SL735													
MOUNTING CONFIG.	SERIES	LENS	NO. OF LEDES	COLOR TEMP K	DISTRIBUTION TYPE	DISTRIBUTION ORIENTATION	DRIVER	CONTROLS	MOTION SENSOR	HOUSE SIDE SHIELD	DUAL FUSE & HOLDER	COLOR	
1-U01S ¹	LARGE AREA FOR U0 ARMS	CA	84L ²	35(00) K	T2	F	MDL03	OPTIONS				UBKT	UBK
1-U01 ¹		FG	112L	45(00) K	T3	R	MDL05	R	MOT1 ²	HSS	FHD	UBT	UB
2-U01 ¹		SA	140L	62(00) K	T3R	L	MDH03	R1	MOT2 ²			ULBT	ULB
1-U02 ¹		FFG				T4	S	MDH05	PEC			USLT	USL
2-U02 ¹		SV1*				T5						UWHT	UWH
1-U03 ¹		SV2**	BLOC OPTICS									UCHS	
2-U03 ¹		SV1SA*	80BL			T3RBL							
1-U04 ¹		SV2SA**	96BL			T4BL							
2-U04 ¹			128BL										

¹See arm specification sheet for complete ordering information. ² Not available in 05 driver

Product Specs

Optical

- BUG rating of U-0.
- IP65 rated optic module.
- Available in IES Type 2, 3, 3R, 4 and 5 distribution.
- Utilizes high output, high brightness LEDs.
- Operates at -40°C (-40°F) to +50°C (122°F) ambient air temperature range.
- Typical CRI of 70, CCT 3500, 4500 and 6200K. Call factory for custom CCT.
- LM-79 and LM-80 tests in accordance with IESNA standards.
- Lumen depreciation rating L₇₀>150,000 hrs. projected per TM-21 guideline using 525mA drive current at 25°C ambient.
- RoHS Compliant.
- Bloc optic available 1st quarter of 2014.

Electrical

- 120-277 volt and 347- 480 volt available.
- Minimum drivers power factor: >0.9.
- Electrical surge protection in accordance with IEEE/ANSI C62.41.2 guidelines.
- UL or ETL listed in U.S. and Canada.

Mechanical

- Cast aluminum heat sink and housing top cover.
- Spun aluminum heat sink and lens cover.
- AAD™ "Advanced Air-flow Dynamics" maximizes heat sink expulsion.

Controls

- Supplied with dimmable driver.
- Optional Roto-lock receptacle only R.
- Optional Roto-lock receptacle with photocell R1.
- Optional electronic button photocell: PEC (120- 277V).

Finish

- Durable, color retentive powder coat finish.

Warranty & Standards

LED Systems and Drivers - 7 years. All fixtures shall be free from all defects in materials and workmanship for a period of 7 years from the date of manufacture. The luminaire manufacturer shall warrant the LED boards/system, during the stated warranty period, against failure defined as more than 10 percent of non-operating LEDs.

Motion Sensors:

- MOT1³:** 360° lens, maximum coverage 40' diameter from 20' height
- MOT2³:** 360° lens, maximum coverage 70' diameter from 20' height

³ Note: Requires acrylic flat lens (CA)

Drivers:

- MDL03:** 350mA, 120-277V
- MDL05:** 525mA, 120-277V
- MDH03:** 350mA, 347-480V
- MDH05:** 525mA, 347-480V

Lens:

- CA** - Clear Flat Acrylic
- FG** - Clear Flat Glass
- SA** - Clear Sag Acrylic
- FFG** - Frosted Flat Glass

Soft Vue:

- SV1*** - Flat Medium Diffuse Acrylic Lens
- SV2**** - Flat Heavy Diffuse Acrylic Lens
- SV1SA*** - Sag Medium Diffuse Acrylic Lens
- SV2SA**** - Sag Heavy Diffuse Acrylic Lens

*Provides moderate reduction in Brightness while only a minimal reduction in lumen output.

**Provides maximum reduction in Brightness while only a nominal reduction in lumen output. Consult photometric files for exact lumen performance as percentages noted are averages.

Colors:

- UBKT** - Urban Black Textured
- UBT** - Urban Bronze Textured
- ULBT** - Urban Light Bronze Textured
- USLT** - Urban Silver Textured
- UWHT** - Urban White Textured
- UCHS** - Urban Champagne Satin Smooth

Distribution Orientation:

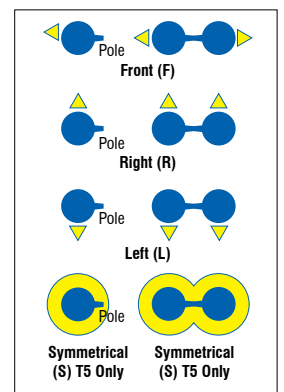

- UBK** - Urban Black Matte
- UB** - Urban Bronze Matte
- ULB** - Urban Light Bronze Matte
- USL** - Urban Silver Matte
- UWH** - Urban White Matte

Performance (Based on FG Lens)

MODEL #	T2 DELIVERED LUMENS	EFFICACY (LPW)	T3 DELIVERED LUMENS	EFFICACY (LPW)	T3R DELIVERED LUMENS	EFFICACY (LPW)	T4 DELIVERED LUMENS	EFFICACY (LPW)	T5 DELIVERED LUMENS	EFFICACY (LPW)	WATTAGE
84L35T_MD_03	8545	89.0	8100	84.4	8635	89.9	8590	89.5	8950	93.2	96
84L45T_MD_03	9110	94.9	8635	89.9	9200	95.8	9155	95.4	9535	99.3	96
84L62T_MD_03	9740	101.5	9230	96.1	9835	102.4	9785	101.9	10195	106.2	96
112L35T_MD_03	11260	89.4	10605	84.2	11345	90.0	11295	89.6	11795	93.6	126
112L45T_MD_03	12000	95.2	11300	89.7	12090	96.0	12035	95.5	12570	99.8	126
112L62T_MD_03	12830	102.8	12080	95.9	12930	102.6	12870	102.1	13440	106.7	126
140L35T_MD_03	14075	90.8	13295	85.8	14280	92.1	14235	91.8	14750	95.2	155
140L45T_MD_03	14995	96.7	14165	91.4	15215	98.2	15170	97.9	15715	101.4	155
140L62T_MD_03	16035	103.5	15145	97.7	16265	104.9	16220	104.6	16805	108.4	155
112L35T_MD_05	15165	77.4	14415	73.5	15420	78.7	15395	78.5	16030	81.8	196
112L45T_MD_05	16160	82.4	15360	78.4	16430	83.8	16405	83.7	17085	87.2	196
112L62T_MD_05	17280	88.2	16425	83.8	17565	89.6	17540	89.5	18265	93.2	196
140L35T_MD_05	18760	77.5	17740	73.3	19080	78.8	19110	79.0	19840	82.0	242
140L45T_MD_05	19990	82.6	18905	78.1	20335	84.0	20360	84.1	21140	87.4	242
140L62T_MD_05	21375	88.3	20215	83.5	21740	89.8	21770	90.0	22605	93.4	242

Product Dimensions and Features

EPA: 0.7 SQUARE FT
WEIGHT: 38 LBS

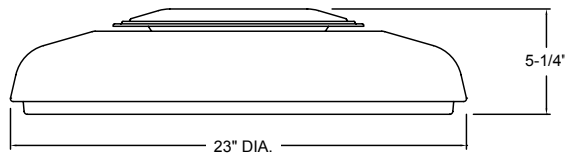

Mounting Configurations

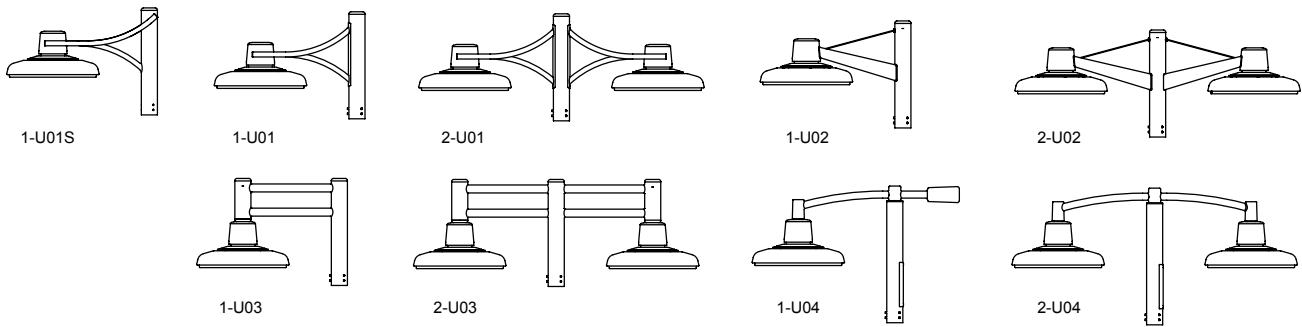

Mounting Details

MOUNTING
HARDWARE
SUPPLIED BY
STERNBERG

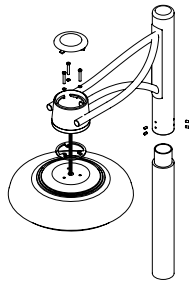

TYPICAL INSTALLATION
U01, U01S, AND U02 ARMS

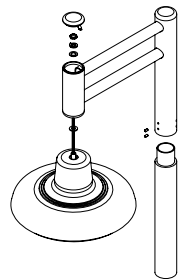

INSTALLATION U03 ARMS

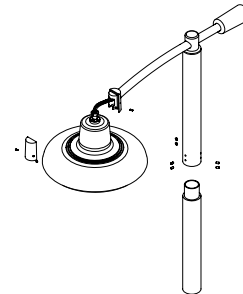

INSTALLATION U04 ARMS

Other Options

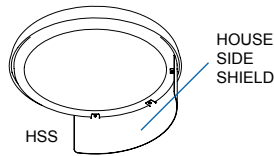
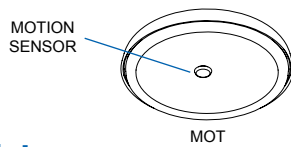

FOR R1 AND PEC
CONSULT FACTORY FOR
LOCATION

ISO Footcandle Plots

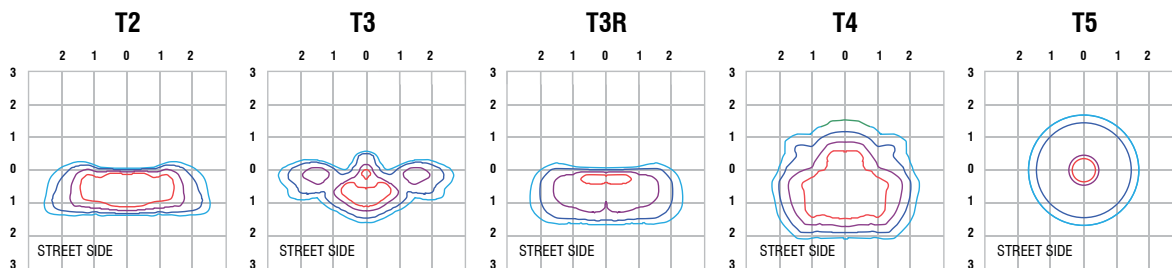

All published luminaire photometric testing performed to IESNA LM-79 standards by NVLAP certified laboratory. ISO footcandle plots above demonstrate the SOLANA'S light patterns only. Not for total fixture output. For complete specifications and IES files, see website.



800-621-3376
555 Lawrence Ave., Roselle, IL 60172
info@sternberglighting.com
www.sternberglighting.com

Performance

MODEL #	T3R DELIVERED LUMENS	EFFICACY (LPW)	B U G	T4 DELIVERED LUMENS	EFFICACY (LPW)	B U G	WATTS
80L35T_-MDL03	7027	76.0	1 0 2	7003	76	1 0 2	92
80L45T_-MDL03	7475	81.0	1 0 2	7450	80	1 0 2	92
80L62T_-MDL03	7998	86.0	1 0 2	7972	86	1 0 2	92
96L35T_-MDL03	8380	76.0	1 0 2	8352	76	1 0 2	109
96L45T_-MDL03	8915	81.0	1 0 2	8885	81	1 0 2	109
96L62T_-MDL03	9539	87.0	1 0 2	9507	87	1 0 2	109
128L35T_-MDL03	11153	77.0	2 0 2	11158	77	1 0 2	144
128L45T_-MDL03	11865	82.0	2 0 2	11870	82	1 0 2	144
128L62T_-MDL03	12696	88.0	2 0 2	12701	88	1 0 2	144
96L35T_-MDL05	11496	66.0	2 0 2	11520	66	1 0 3	173
96L45T_-MDL05	12230	70.0	2 0 2	12255	70	1 0 3	173
96L62T_-MDL05	13086	75.0	2 0 2	13113	75	1 0 3	173
128L35T_-MDL05	15007	66.0	2 0 3	15129	67	2 0 3	224
128L45T_-MDL05	15965	71.0	2 0 3	16095	71	2 0 3	224
128L62T_-MDL05	17083	76.0	2 0 3	17222	76	2 0 3	224

