

**RSL/RWSL SERIES**

**SPECIFICATIONS**

**GENERAL**

The RSL/RWSL series is a traditional railroad downlight fixture which consists of a spun aluminum rippled edge shade and optic lens.

**BALLAST**

The ballast shall be remote mounted in the base of the pole, pole shaft, arm or ballast box.

**ELECTRICAL**

The fixture shall be U.L. or E.T.L. listed. H.I.D. ballasts shall be high power factor with lamp starting down to -30 degrees C. Medium base porcelain sockets are 4KV rated. All compact fluorescent (PL) ballasts shall be instant start electronic with a starting temperature of down to 0 degrees F. They shall have a 4-pin socket to accept quad or triple tube lamps. Ballasts shall be DOE EISA compliant.

**SHADE**

The **RSL** shade shall be made of .100 thick spun aluminum and have an outside diameter of 14" (Model RSL14), 21" (Model RSL21), 27" (Model RSL27). It shall be have a smooth spun neck for connection to an arm end or tenon. The shade shall be mechanically attached to the arm using a 3/8" threaded pipe and gasket washer.

The **RWL** shade shall be made of .100 thick spun aluminum and have an outside diameter of 18" (Model RWL18), 20" (Model RWL20), 24" (Model RWL24). It shall be have stepped spun neck for connection to an arm end or tenon. The shade shall be mechanically attached to the arm using a 3/8" threaded pipe and gasket washer.

**OPTICAL OPTIONS**

The fixture shall be supplied with a Refractor lens which shall be 9" diameter polycarbonate with an I.E.S. Type 3 distribution (R3P) or Type 5 distribution (R5P). It shall be secured to the spun holder with a spring snap ring.

The fixture shall be supplied with a Glass Jar Lamp Protector (GJ) is a clear glass jar which envelops the lamp and is threaded into a cast aluminum holder. It shall have an aluminum guard over the lens.

The fixture shall be supplied with a White Glass Globe (G10) which shall measure 10" diameter and envelops the lamp and is mechanically attached to its holder.

The fixture shall be supplied with a 1910 Acorn which shall be made of clear frosted polycarbonate and envelops the lamp. Type 3 (RE3) or Type 5 (RE5), glass refractor is optional.

**INTEGRAL BALLAST FITTER OPTION**

The shade assembly shall be attached to a decorative cast fitter and contain a ballast housing which shall be shall be heavy wall cast aluminum, 319 alloy for high tensile strength. The housing

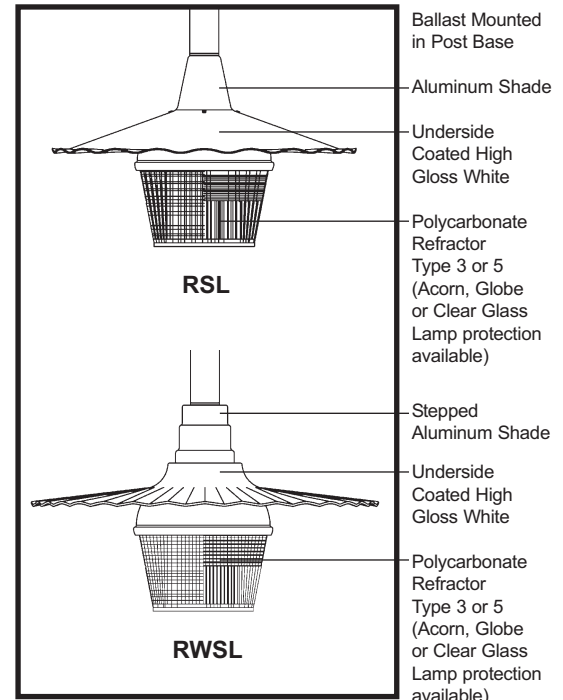

**RSL EPA = 0.21 (ft<sup>2</sup>)  
WEIGHT = 8 LBS**

# RSL/RWSL SERIES

# FIXTURES / ARMS PM - WB

## FIXTURES

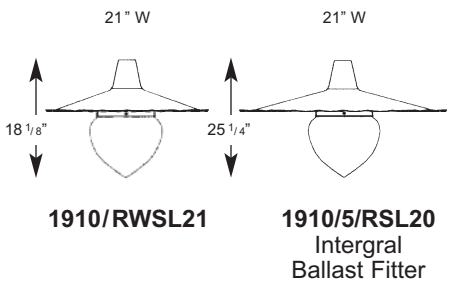
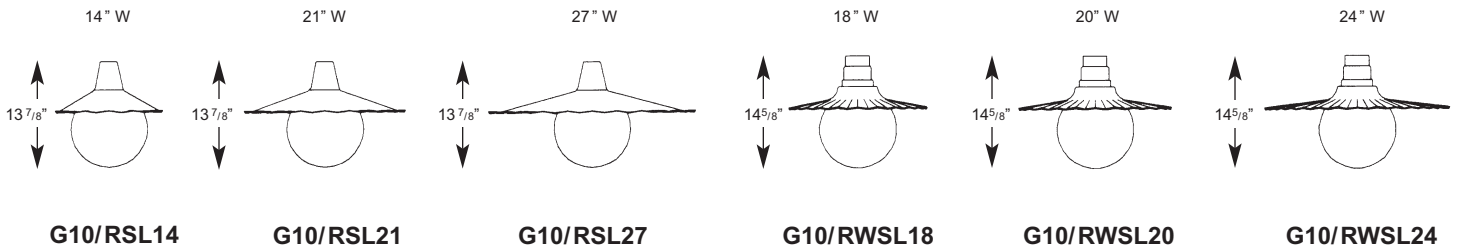
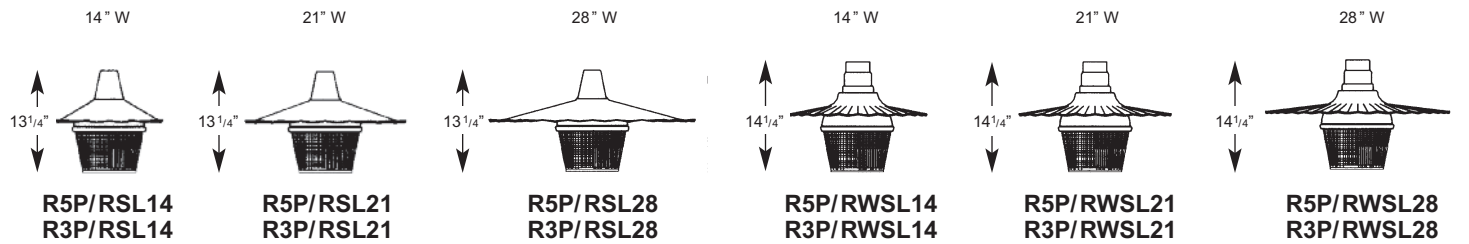
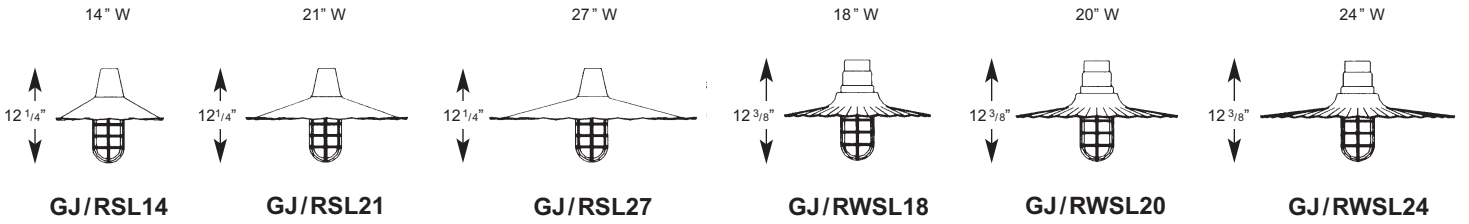

Optics for 1910 Models



<b>BALLASTED WALL MOUNTS</b>	<b>HANGING BRACKETS</b>	<b>BALLASTED CEILING MOUNTS</b>
------------------------------	-------------------------	---------------------------------

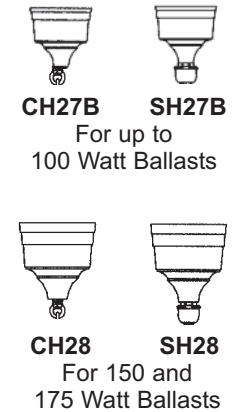
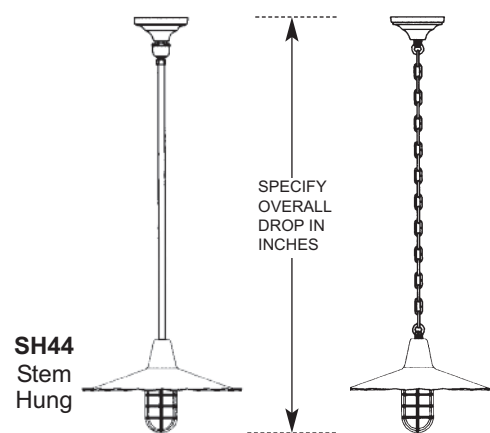
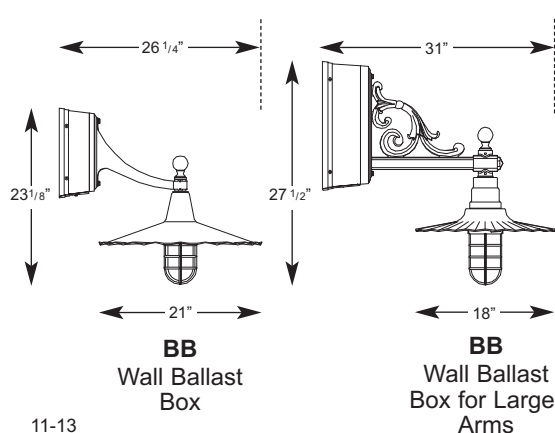

**RSL/RWSL SERIES**

**FIXTURES / ARMS PM - WB**

**ARMS - POST MOUNT (PM) or WALL BRACKETS (WB)** See Arms Section for more information

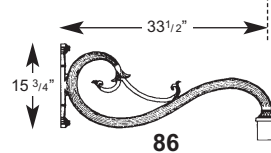
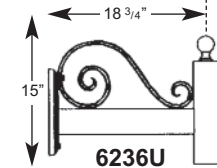
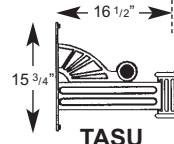
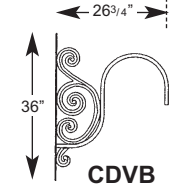
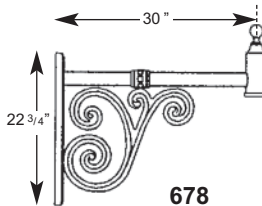
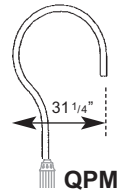
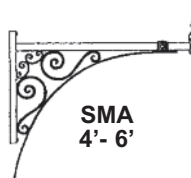
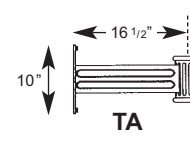
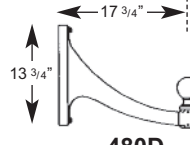
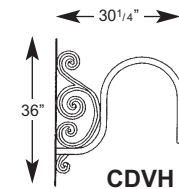
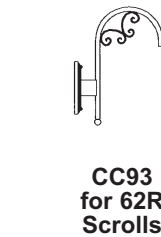
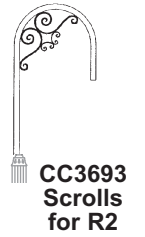
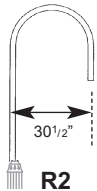
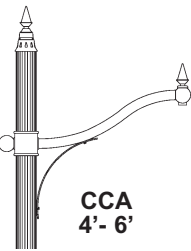
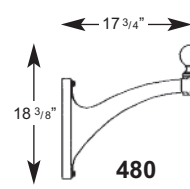
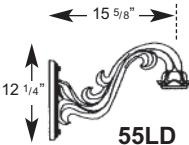
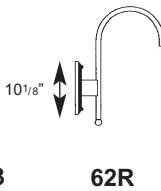
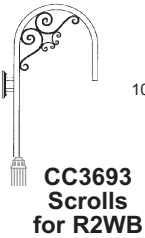
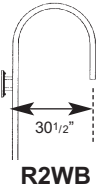
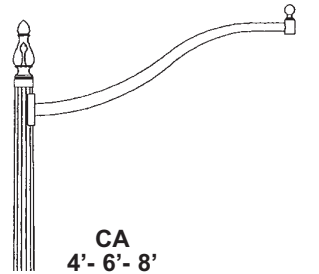
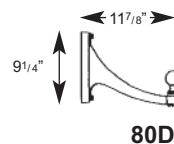
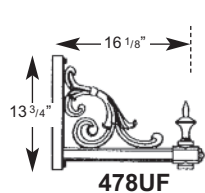
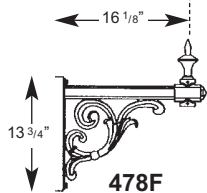
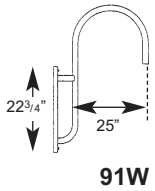
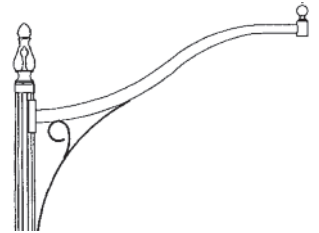
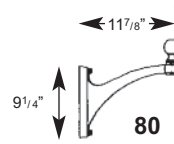
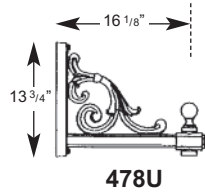
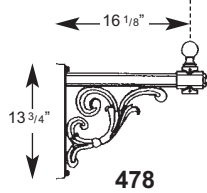
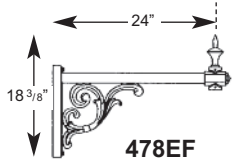

# BUILDING A PART NUMBER



## POST & ARM FIXTURES

ARM MOUNTED FIXTURE NO.	CENTER POST TOP FIXTURE (PT)	POST	POST CAP	LIGHT SOURCE BALLAST	OPTICS	OPTIONS	FINISH
2	GJ/RWSL20/RPM	PT	3900RT4-12AG	50 HPS120		HPS50/MED	BK

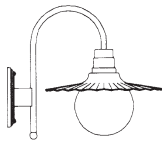

## WALL FIXTURES

FIXTURE / WALL BRACKET	LIGHT SOURCE BALLAST	OPTICS	OPTIONS	FINISH
G10RWSL20/62RWB	INCAND			BK

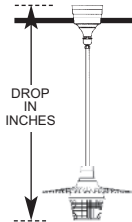

## HANGING FIXTURES

FIXTURE / HANGING BRACKET	OVERALL DROP IN INCHES	LIGHT SOURCE BALLAST	OPTICS	OPTIONS	FINISH
R5P/RWSL20/SH28	48 INCHES	150 HPS120		HPS150/MED	BK

## PART NUMBER SELECTIONS

### FIXTURES<sup>4</sup>

- GJ/RSL14
- GJ/RSL21
- GJ/RSL27
- R5P/RSL14
- R3P/RSL14
- R5P/RSL21
- R3P/RSL21
- R5P/RSL27
- R3P/RSL27
- G10/RSL14
- G10/RSL21
- G10/RSL27
- GJ/RWSL18
- GJ/RWSL20
- GJ/RWSL24
- R5P/RWSL18
- R3P/RWSL18
- R5P/RWSL20
- R3P/RWSL20
- R5P/RWSL24
- R3P/RWSL24
- G10/RWSL18
- G10/RWSL20
- G10/RWSL24
- 1910/RWSL21
- 1910/5/RSL21

### POST ARMS

- 86PM
- 80PM
- 80DPM
- 480PM
- 480DPM
- 478PM
- 478FPM
- 478UPM
- 478UFPM
- TAPT
- TASUCRPT
- 478EFPM
- 678PM
- 55LDPM
- 6236UPM
- CDVHPM
- 91WPM
- RPM
- QPM
- CA4<sup>3</sup>
- CA6<sup>3</sup>
- CA8<sup>3</sup>
- SMA4<sup>3</sup>
- SMA6<sup>3</sup>
- CCA4<sup>3</sup>
- CCA6<sup>3</sup>
- CAS4<sup>3</sup>
- CAS6<sup>3</sup>
- CAS8<sup>3</sup>

### WALL BRACKET ARMS

- 86WB
- 80WB
- 480WB
- 80DWB
- 480WB
- 480DWB
- 478WB
- 478FWB
- 478UWB
- 478UFWB
- TAWB
- TASUWB
- 478EFWB
- 678WB
- 55LDWB
- 6236UWB
- CDVHWB
- 91WWB
- R2WB
- 62RWB

### VOLTAGES

- 120
- 208
- 240
- 277
- 480
- MULTI (120-277)

### WALL BRACKET ARMS WITH BALLAST BOX

- 80WB
- 80DWB
- 480WB
- 480DWB
- 478WB
- 478FWB
- 478UWB
- 478UFWB
- TAWB
- TASUWB
- 478EFWB
- 478FWB
- 55LDWB
- 6236UWB
- 91WWB
- R2WB
- 62RWB

### BALLASTS<sup>2,5</sup>

- 35HPS<sup>1</sup>
- 50HPS
- 70HPS
- 100HPS
- 150HPS
- 50MHP
- 70MHP
- 100MHP
- 150MHP
- 26PLT
- 32PLT
- 42PLT
- INCAND

### OPTICS<sup>6</sup>

- RE3
- RE5
- HSS

### LAMPS<sup>5</sup>

- HPS35/MED
- HPS50/MED
- HPS70/MED
- HPS100/MED
- HPS150/MED
- MHP50/MED
- MHP70/MED
- MHP100/MED
- MHP150/MED
- PLT26
- PLT32
- PLT42

### HANGING BRACKETS

- CH44
- SH44
- CH27B
- SH27B
- CH28
- SH28

### STANDARD FINISHES\*

- BKT Black Textured
  - WHT White Textured
  - PGT Park Green Textured
  - ABZT Architectural Medium Bronze Textured
  - DBT Dark Bronze Textured
- \*Smooth Finishes are available upon request

### CUSTOM FINISHES

- OI Old Iron
- RT Rust
- WBR Weathered Brown
- CD Cedar
- WBK Weathered Black
- TT Two Tone

### STERNBERG SELECT FINISHES

- VG Verde Green
- SI Swedish Iron
- OWGT Old World Gray Textured

### OPTIONS

- PEC1 Photocell-Bimetal 120 Volt
- PEC2 Photocell-Bimetal 208-277 Volt
- PEC1-E Photocell-Electronic 120 Volt
- PEC2-E Photocell-Electronic 208-277 Volt
- FHS Single Fuse and Holder-120,277 Volt
- FHD Dual Fuse and Holder-208,240,480 Volt
- PF Pineapple Finial or Font (TA, TASCRA)
- BF Ball Finial or Font (TA, TASCRA)
- CC3693 Scrolls for R2 Arm
- CC93 Scrolls for 62R Arm
- HS Hangstraight
- LAMPS Select from List

### NOTES:

- 35HPS is 120 volt only.
- Medium base socket is standard with ballasts up to 175 watts HID. 4-pin for PL.
- Add (S) Spike or (B) Ball after arm to designate type of finial.
- Remote ballast or ballast box required.
- Metal halide systems are pulse start.
- For 1910 models only.

**RSL/RWSL SERIES****SPECIFICATIONS****LIST NO.  
RSL/RWSL  
SERIES**

shall be mounted to the cast fitter with two screws, 1/4" x 1/2" long stainless steel slotted pan head and to include a one-piece water gasket ring to prevent water entry into the ballast compartment. The ballast shall be attached to the ballast housing by two aluminum wide faced "Z" brackets to ensure high capacity heat sinking of ballast temperatures, keeping the ballast cooler and ensuring long life.

**PHOTOCELLS**

Photocells shall be either the thermo bi-metal button type or the electronic button type. On single post top fixtures the photocell shall be mounted in the fitter and pre-wired to ballast. On multiple head fixture assemblies photocells shall be mounted in the pole shaft on an access plate and are not pre-wired as ballast housing assemblies and fitters are packaged separately for ease of wiring to source. The thermo bi-metal photocell shall be designed to turn on at 1.0 footcandle and turn off at not more than 5 footcandles. The electronic button type photocell is instant on and a 5-10 second turn off and shall turn on at 1.5 footcandles with a turn-off at 2-3 footcandles. Photocells are either 120 volt or 208 thru 277 volt.

**ARMS**

All arms are made of cast aluminum and/or extruded aluminum. Arms with decorative filigree have meticulously detailed scroll work and gracefully curved brackets. All fixtures will have its fitter either welded to the arm or will be mechanically attached at the factory to ensure arms will be plumb, secure and level over the life of the installation. Each arm shall be bolted to a post mount adapter, which is welded to the pole to ensure proper alignment to the base. Arms are pre-wired for ease of installation.

**FINISH**

Prior to coating, each assembly shall be chemically cleaned and etched in a 5-stage washing system which includes alkaline cleaning, rinsing, phosphoric etching, reverse osmosis water rinsing and non-chrome sealing to ensure corrosion resistance and excellent adhesion for the finish coating. The finish coating shall be electrostatically applied semi-gloss, super durable polyester powder baked at 400 degrees for a durable and superior, color retentive finish. Our optional antique Verde Green finish and Swedish Iron finish are hand brushed using a 3-step process. The total assembly shall be wrapped in shockproof wrapping or fully enclosed in corrugated cartons.

**WARRANTY**

Five-year limited warranty. See product and finish warranty guide for details.

