

1730 VILLA SERIES

SPECIFICATIONS

GENERAL

The 1730 Villa fixture is a large scale, dramatic design. It features a tall, cylindrical architectural body consisting of a decorative cast cage, round lens and round flat roof shade. It shall provide tool-less access for ease of maintenance.

POST FITTER

The fitter shall be heavy wall cast aluminum, 356 alloy for high tensile strength. It shall have an inside diameter opening to accept a 3", 4" or 5" round pole or tenon. When ordered with a Sternberg aluminum pole, the fitter shall be set screwed to the pole top or tenon.

BALLAST HOUSING

The ballast housing shall be heavy wall cast aluminum, 356 alloy for high tensile strength. The housing shall be cast as an integral part of the fitter to prevent water entry into the ballast compartment and to ensure high capacity heat sinking of ballast temperatures, keeping the ballast cooler and ensuring long life. The ballast mounting plate shall be cast aluminum and provide tool-less removal from the housing using 2 ea latches.

ELECTRICAL

Fixture shall be U.L. or E.T.L. listed in U.S. and Canada. H.I.D. ballasts shall be high power factor with lamp starting down to -30 degrees C. Medium base and mogul base porcelain sockets are 4KV rated. The ballast/socket assembly shall be pre-wired when ballast is located in the fixture. Ballasts shall be DOE EISA compliant.

FIXTURE HOUSING

The 1730 fixture shall be 30" wide and the overall height shall be 32". It shall be made of heavy wall cast aluminum, 356 alloy, aluminum shade and lens will be made of vandal resistant clear or frosted acrylic.

OPTICAL OPTIONS

Refractors shall be 6" diameter borosilicate glass with an I.E.S. Type 3 (RE3) or Type 5 (RE5) distribution. It shall be secured to the socket stem with 3/8" plated steel threaded pipe nipple and rest on a cast aluminum holder with anti-shock gasket. The refractor will be secured to cast holder with a quarter-turn internal aluminum twist ring for ease of maintenance.

The NIGHTSKY® OPTI-SHIELD® Louver Optic System (LO) shall be a multi-tier reflector with 7" diameter rings to produce an I.E.S. Cut-off Type 3 or 5 distribution. The Louver Optic System shall be made of highly specular anodized aluminum and shall come standard with medium base socket.

Frosted Glass Mission Chimney (FMC) is an optic option which adds an authentic touch.

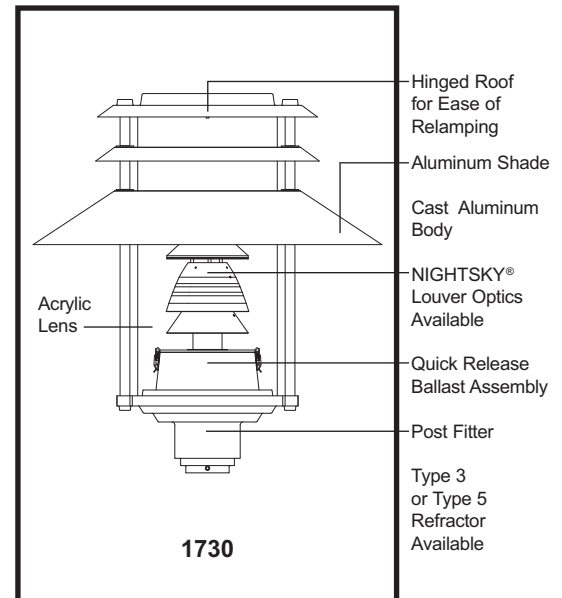





EPA = 0.97 (ft²)
WEIGHT = 35 LBS

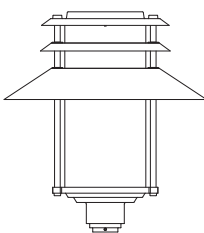
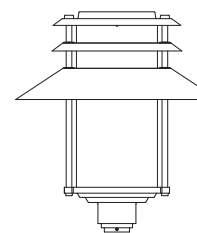

1730 VILLA

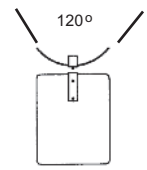
FIXTURES/FITTERS/ARMS PM-WB

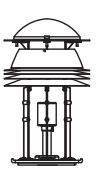
FIXTURES POST FITTERS OPTICAL SYSTEMS

30" W	30" W					
						
1730CA Clear Acrylic Lens	1730FA Frosted Acrylic Lens	R3" R4" R5" SIZES	RE3 RE5 Refractor	HSS House Side Shield	FMC Frosted Mission Chimney	LO3 LO5 Louver Optics

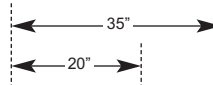
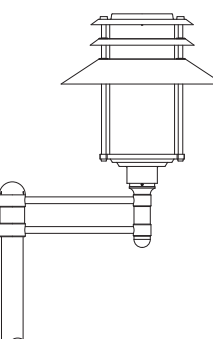
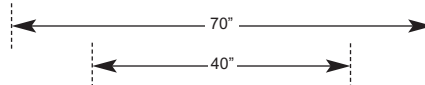
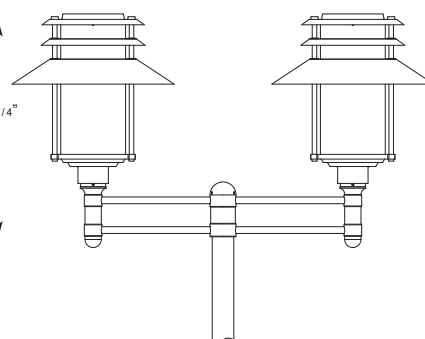
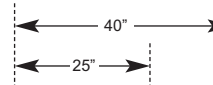
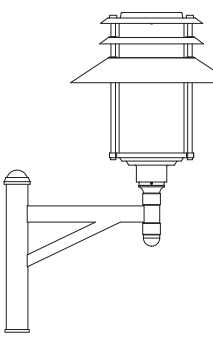
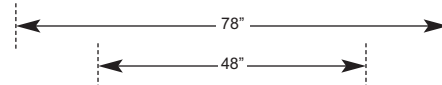
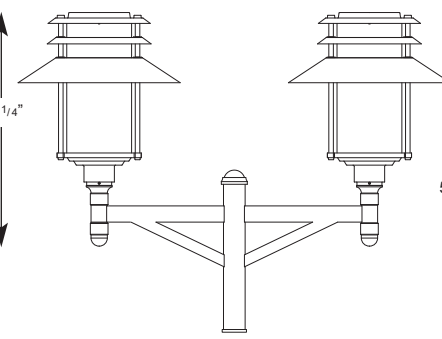
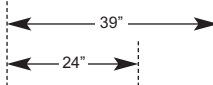
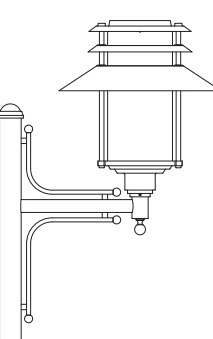
ARMS - POST MOUNT or WALL BRACKETS (WB) See Arms Section for more information

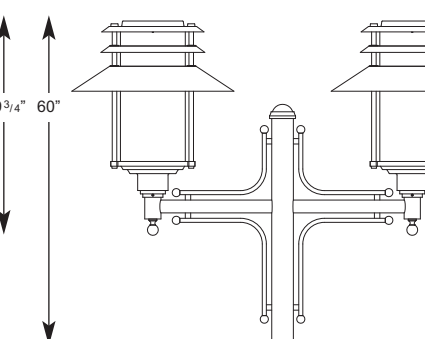
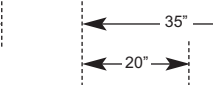
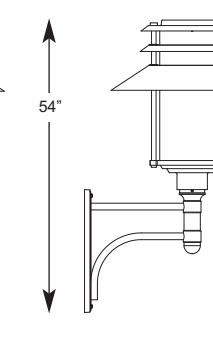
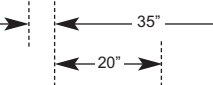
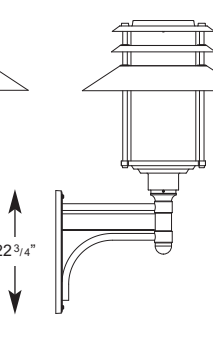
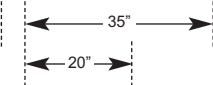
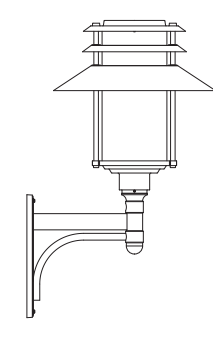
  OM SINGLE	  OM TWIN	  HMPT SINGLE	  HMPT TWIN	
  OL SINGLE	  OL TWIN	  VC	  VL	  VF

BUILDING A PART NUMBER

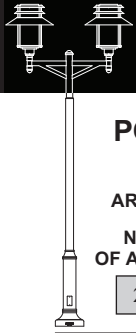

POST & ARM FIXTURES

ARM MOUNTED FIXTURE	CENTER POST TOP FIXTURE (PT)	POST	POST CAP	LIGHT SOURCE BALLAST	OPTICS	OPTIONS	FINISH
NO. OF ARMS 2	FIXTURE / POST ARM 1730CA/HMPT	FIXT./FITTER PT	(See Post Section) 3320P5	BC	100 MHP120	LO3	PEC / BKT

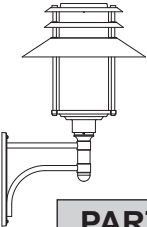

WALL FIXTURES

FIXTURE / WALL BRACKET	LIGHT SOURCE BALLAST	OPTICS	OPTIONS	FINISH
1730CA/VCWB	100 MHP120	LO3	MHP100/MED	BKT

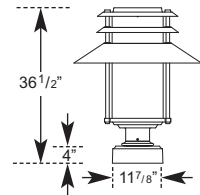

PIER FIXTURES
Uses same information boxes as wall fixture
1730FA/550PB
FIXTURE / PIER BASE

PART NUMBER SELECTIONS

FIXTURE

- 1730CA
- 1730FA

FITTERS

- R3
- R4
- R5

OPTICS

- RE3
- RE5
- HSS
- FMC²
- LO3
- LO5

POST ARMS

- OMPT
- HMPT
- OLPT
- VCPM
- VLPM
- VFPM

VOLTAGES

- 120
- 208
- 240
- 277
- 480
- MULTI (120-277)

WALL BRACKET ARMS

- OMWB
- HMWB
- OLWB
- VCWB
- VLWB
- VFWB

PIER BASE

- 550PB

BALLASTS^{3,4}

- 35HPS¹
- 50HPS
- 70HPS
- 100HPS
- 150HPS
- 250HPS
- 50MHP
- 70MHP
- 100MHP
- 150MHP
- 200MHP
- 250MHP

LAMPS⁴

- HPS35/MED
- HPS50/MED
- HPS70/MED
- HPS100/MED
- HPS150/MED
- HPS250/MOG/ED18
- MHP50/MED
- MHP70/MED
- MHP100/MED
- MHP150/MED
- MHP200/MOG/ED28
- MHP250/MOG/ED28

STANDARD FINISHES*

- BKT Black Textured
- WHT White Textured
- PGT Park Green Textured
- ABZT Architectural Medium Bronze Textured
- DBT Dark Bronze Textured

*Smooth Finishes are available upon request

CUSTOM FINISHES

- OI Old Iron
- RT Rust
- WBR Weathered Brown
- CD Cedar
- WBK Weathered Black
- TT Two Tone

OPTIONS

- PEC1 Photocell-Bimetal 120 Volt
- PEC2 Photocell-Bimetal 208-277 Volt
- PEC1-E Photocell-Electronic 120 Volt
- PEC2-E Photocell-Electronic 208-277 Volt
- FHS Single Fuse and Holder-120,277 Volt
- FHD Dual Fuse and Holder-208,240,480 Volt
- QR Quartz Re-Strike
- LAMPS Select from List

NOTES:

- ¹ 35HPS is 120 volt only.
- ² MED base only when used to house lamp.
- ³ Medium base sockets standard with ballasts up to 150 watts HID. Mogul base sockets are standard with ballasts 200 watts and over.
- ⁴ Metal halide systems are pulse start.

1730 VILLA SERIES

SPECIFICATIONS

**LIST NO.
1730 VILLA
SERIES**

House Side Shield (HSS) is an option which will block up to 120° of light in any one direction.

QUARTZ RE-STRIKE

The 1730 fixture can be supplied with an optional quartz re-strike system to retain constant fixture light if the H.I.D. lamp fails. The fixture will be equipped with a 100 watt quartz lamp and a controller to run on a 120 volt circuit and must be used in conjunction with a 120 volt or multi-tap ballast.

PHOTOCELLS

Photocells shall be either the thermo bi-metal button type or the electronic button type. On single post top fixtures the photocell shall be mounted in the fitter and pre-wired to ballast. On multiple head fixture assemblies photocells shall be mounted in the pole shaft on an access plate and are not pre-wired as ballast housing assemblies and fitters are packaged separately for ease of wiring to source. The thermo bi-metal photocell shall be designed to turn on at 1.0 footcandle and turn off at not more than 5 footcandles. The electronic button type photocell is instant on and a 5-10 second turn off and shall turn on at 1.5 footcandles with a turn-off at 2-3 footcandles. Photocells are either 120 volt or 208 thru 277 volt.

ARMS

All arms are made of cast aluminum and/or extruded aluminum. Arms with decorative filigree have meticulously detailed scroll work and gracefully curved brackets. All 1730 fixtures shall be bolted to the arm to ensure arms will be plumb, secure and level over the life of the installation.

FINISH

Prior to coating, each assembly shall be chemically cleaned and etched in a 5-stage washing system which includes alkaline cleaning, rinsing, phosphoric etching, reverse osmosis water rinsing and non-chrome sealing to ensure corrosion resistance and excellent adhesion for the finish coating. The finish coating shall be electrostatically applied semi-gloss, super durable polyester powder baked at 400 degrees for a durable and superior, color retentive finish. Our optional antique Verde Green finish and Swedish Iron finish are hand brushed using a 3-step process. The total assembly shall be wrapped in shockproof wrapping or fully enclosed in corrugated cartons.

WARRANTY

Five-year limited warranty. See product and finish warranty guide for details.

